

# Revalco®

Made in Italy

## measurement transducers



### USCITE SELEZIONABILI





# MEASUREMENT TRANSDUCERS

GENERAL DESCRIPTION .....	144
POWER SUPPLIES .....	144
ORDERING DATA .....	144
WAVEFORM .....	144
LINEARITY DIAGRAMS BETWEEN INPUTS AND OUTPUTS .....	144
DIMENSIONS in mm .....	144
MEASUREMENT TRANSDUCERS - TRUE RMS .....	145
CURRENT TRANSDUCERS	
A.C. transducers .....	146
D.C. transducers .....	146
VOLTAGE TRANSDUCERS	
A.C. transducers .....	147
D.C. transducers .....	147
POWER FACTOR TRANSDUCERS	
Single phase .....	148
Three phase .....	148
FREQUENCY TRANSDUCERS .....	148
ACTIVE AND REACTIVE POWER TRANSDUCERS	
Single phase .....	149
THREE PHASE ACTIVE AND REACTIVE POWER TRANSDUCERS	
Balanced load, 3 wires without neutral .....	150
Unbalanced load, 3 wires without neutral (ARON) .....	151
Balanced load, 4 wires with neutral .....	152
Unbalanced load, 4 wires with neutral .....	153

## GENERAL DESCRIPTION

- The transducer is a device that measures a given electrical parameter, which is then through electronic circuitry, converted to a DC signal, which is directly proportional to the input, to allow remote indication without loss of accuracy.
- The **Revalco** range of transducers, having galvanic separation between Input and Output, has been developed to a high specification giving the user, confidence with the Accuracy and Linearity over a wide range of measured parameters. Having Low Power Consumption while being unaffected by any changes in Temperature, Vibration or Load, ensures this range is suitable for many applications in the Power Monitoring and Distribution fields.
- **Revalco** transducers have been designed with the ever changing needs of the market in mind. Each item has incorporated the ability to select any of the recognised outputs of both DC mA and DC V by simple selection of minidip keys located under a removable section of the upper case wall

## POWER SUPPLIES

### A.C. CURRENT (for all models)

- Standard power supply 230V +/- 10% a 50/60Hz galvanically insulated
- Other power supply 110V and 24V

### A.C. AND D.C. CURRENT

- Putting "P1" suffix to the standard code, we delivery an instrument with this power supply: 22....36VAC and 19....70VDC
- Putting "P2" suffix to the standard code, we delivery an instrument with this power supply: 44....130VAC and 70....240VDC

## ORDERING DATA

- The three phase active and reactive power transducers are calibrated with the following standard values:  
Current input 5A and the primary values are selectable by minidips  
Voltage input 400V
- On request it is possible to calibrate the transducers with the following parameters which must be indicated when ordering:  
Current input 1A  
Voltage input: 100/ $\sqrt{3}$ V, 110/ $\sqrt{3}$ V, 100V, 110V, 230V, 440V, 500V
- When ordering, the end scale value must be indicated

## WAVEFORM

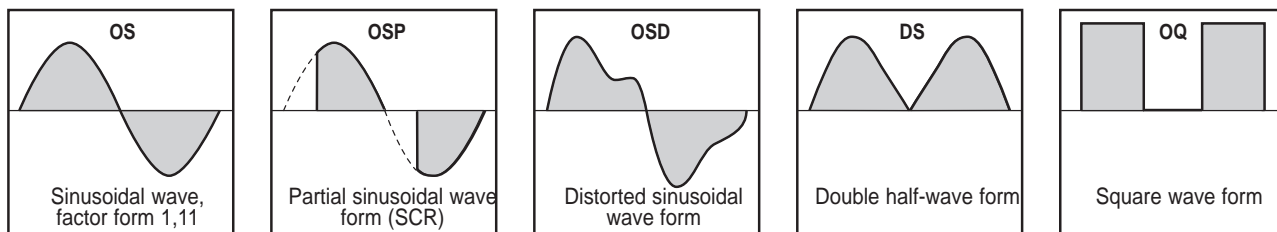

## LINEARITY DIAGRAMS BETWEEN INPUTS AND OUTPUTS

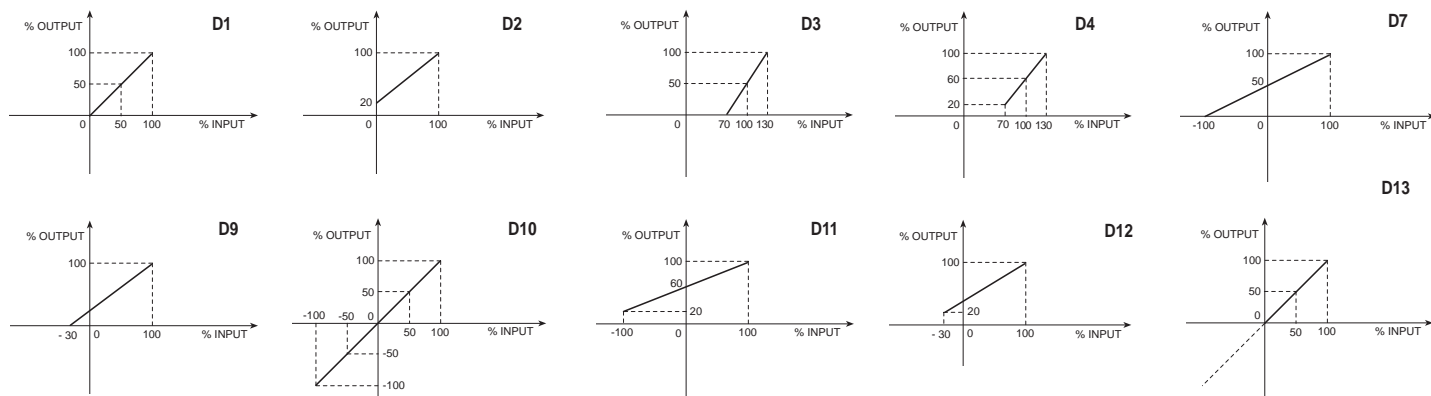

## DIMENSIONS in mm

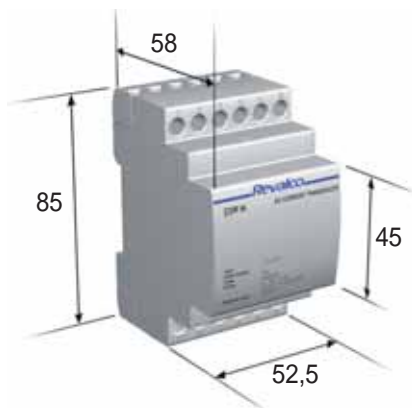

■ The 52,5 mm dimension corresponds to 3 DIN modules

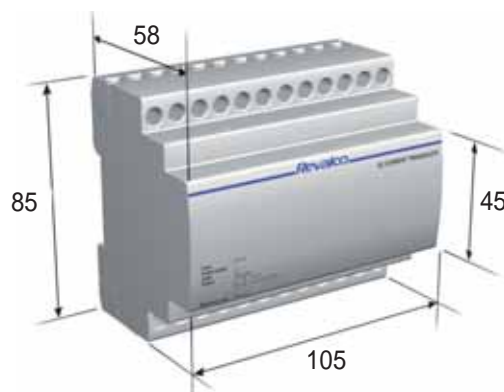

■ The 105 mm dimension corresponds to 6 DIN modules

# MEASUREMENT TRANSDUCERS - TRUE RMS

## SINGLE PHASE

- Auxiliary power supply: see table
- Input nominal values: see table
- Response time  $\leq 300$  ms
- Dimensions: 2 DIN modules

- Selectable output nominal values 1-5-10VDC and 1-5-10-20-4/20mA DC
- Resistive load:  $700\Omega$
- Class 0,5
- Transparent sealable front cover

Preliminary range  
Contact REVALCO for delivery time information



	230	1COR2A...	1COR2V...	1COR2F...	1COR2P...
Current transducers	230	•			
Voltage transducers	230		•		
Frequency transducers	230			•	
Single phase active power transducers	230				•
DC line power transducers	230				•
Sole power supply 24VAC	24	•	•	•	•
Sole power supply 110VAC	110	•	•	•	•
Sole power supply 22...36VAC and 19...70VDC	-P1	•	•	•	•
Sole power supply 44...130VAC and 70...240VDC	-P2	•	•	•	•

PRICES ON REQUEST

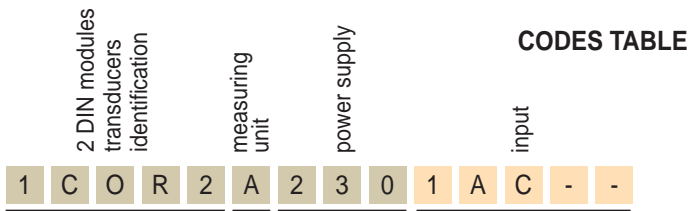

- 230 = 230VAC
- 24 = 24VAC
- 110 = 110VAC
- P1 = 22...36VAC and 19...70VDC
- P2 = 44...130VAC and 70...240VDC

- A = current
- V = voltage
- F = frequency
- P = active power
- C = DC line power

- 1AC-- = input 1A AC (internal CT measurement)
- 5AC-- = input 5A AC (internal CT measurement)
- 5DC-- = input 5A DC
- 10DC- = input 10A DC
- 60MV- = input 60mV DC

- 500-- = input 500V AC or DC
- 100-- = input 100V AC or DC
- 110-- = input 110V AC or DC
- 150-- = input 150V AC or DC
- 250-- = input 250V AC or DC
- 100R3 = input  $100V:\sqrt{3}$  AC or DC
- 110R3 = input  $110V:\sqrt{3}$  AC or DC

- 4555- = input 45/55 Hz
- 4565- = input 45/65 Hz

- 5A500 = calibration 5A 500V AC (internal CT measurement)

- 5A50- = calibration 5A 50V DC (voltage/current measure has a common point)

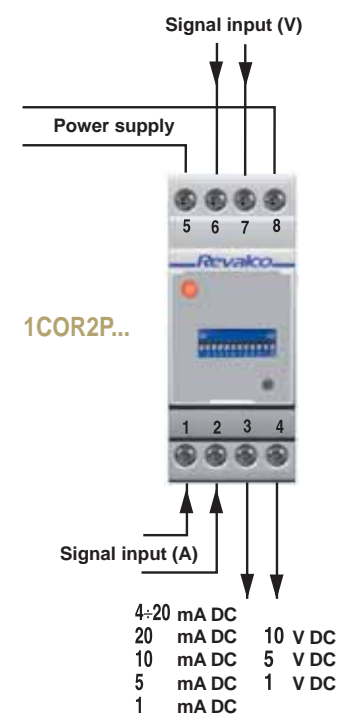
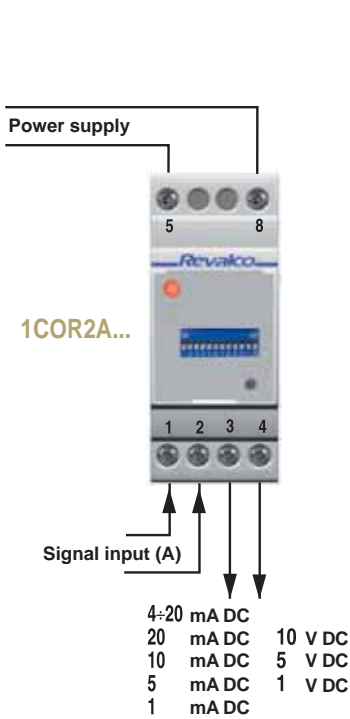
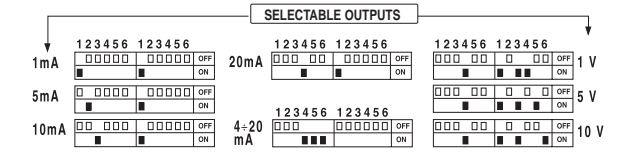

# MEASUREMENT TRANSDUCERS

## CURRENT TRANSDUCERS

### SELF SUPPLIED

- NOMINAL INPUT VALUES
- NOMINAL OUTPUT VALUES
- RESISTIVE LOAD
- MEASURING RANGE
- ACCURACY CLASS
- OVERLOAD
- RESPONSE TIME
- ALTERNATED RESIDUAL
- OPERATING FREQUENCY
- BURDEN
- GALVANIC SEPARATION BETWEEN INPUTS AND OUTPUTS
- OPERATING TEMPERATURE
- INPUT WAVE FORM
- DIMENSIONS / WEIGHT kg.
- Different technical characteristic can be considered, under specific requests

#### 1CORIAA5 20

5A  
20 mA CC  
300Ω

#### 1CORIAA1 20

1A  
20 mA CC  
300Ω

#### 1CORIAA5 10

5A  
10 V CC  
>10kΩ

#### 1CORIAA1 10

1A  
10 V CC  
>10kΩ

0 ÷ In  
1  
Permanent: 1,2 In Instantaneous: 10 In for 1 sec.  
≤ 300 ms  
≤ 2%  
50/60 Hz  
3 VA  
2kV for 1min at 50Hz  
0 °C ÷ +55 °C  
OS  
2 DIN modules / 0,25



### EXTERNAL POWER SUPPLY - 1CORIA

- AUXILIARY SUPPLY (separate)
- NOMINAL INPUT VALUES
- NOMINAL OUTPUT VALUES (selectable)
- RESISTIVE LOAD
- MEASURING RANGE
- ACCURACY CLASS
- OVERLOAD
- RESPONSE TIME
- ALTERNATED RESIDUAL
- OPERATING FREQUENCY
- BURDEN
- GALVANIC SEPARATION BETWEEN INPUTS AND OUTPUTS
  - insulation between inputs, outputs, power supply
  - insulation between the all circuits and earth
- OPERATING TEMPERATURE
- INPUT WAVE FORM
- DIMENSIONS / WEIGHT Kg.
- Different technical characteristic can be considered, under specific requests

#### 1CORIA - AC

230V AC standard

1A and 5A present on the same transducer

1 - 5 - 10 VDC and 1 - 5 - 10 - 20 - 4/20 mA DC

700Ω

0 ÷ In

0,5

Permanent: 2 In Instantaneous: 10 In for 1 sec.  
≤ 300 ms  
≤ 1%

50/60 Hz

current circuit: ≤ 0,8 VA - power supply: ≤ 4VA

2kV for 1min at 50Hz

4kV for 1min at 50Hz

0 °C ÷ +55 °C

OS

3 DIN modules / 0,27

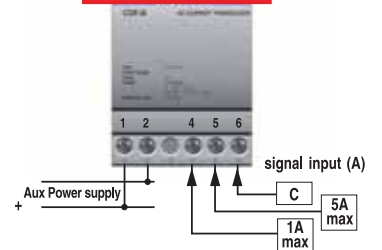
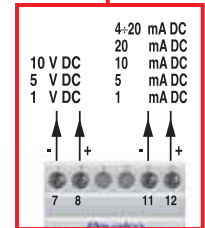

The selection of the required output is achieved by adjusting the minidip keys as described in the following diagram:

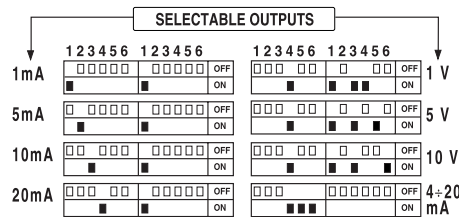

Where a Voltage output is required connection is by terminal Nos, 7 and 8 and for Current output connect to terminals Nos, 11 and 12.

#### Input terminal selection

Input connection is achieved by using Terminal C (No.6) for the common. Then for an Input of 1 Amp select terminal No.4 and for an Input of 5 Amp select terminal No.5 (as shown in the diagram)

# VOLTAGE TRANSDUCERS

## SELF SUPPLIED

	1CORUAA 100 20	1CORUAA 100R3 20	1CORUAA 230 20	1CORUAA 400 20	1CORUAA 100 10	1CORUAA 100R3 10	1CORUAA 230 10	1CORUAA 400 10
- NOMINAL INPUT VALUES	100V	100:√3V	230V	400V	100V	100:√3V	230V	400V
- NOMINAL OUTPUT VALUES	20 mA DC	20 mA DC	20 mA DC	20 mA DC	10 V DC	10 V DC	10 V DC	10 V DC
- RESISTIVE LOAD	300Ω	300Ω	300Ω	300Ω	>10kΩ	>10kΩ	>10kΩ	>10kΩ
- MEASURING RANGE	0 ÷ In							
- ACCURACY CLASS	1							
- OVERLOAD	Permanent: 1,2 In    Instantaneous: 10 In for 1 sec.							
- RESPONSE TIME	≤ 300 ms							
- ALTERNATED RESIDUAL	≤ 2%							
- OPERATING FREQUENCY	50/60 Hz							
- BURDEN	3 VA							
- GALVANIC SEPARATION BETWEEN INPUTS AND OUTPUTS	2kV for 1min at 50Hz							
- OPERATING TEMPERATURE	0 °C ÷ +55 °C							
- INPUT WAVE FORM	OS							
- DIMENSIONS / WEIGHT Kg.	2 DIN modules / 0,25							
- Different technical characteristic can be considered, under specific requests								



## EXTERNAL POWER SUPPLY - 1CORUA

	1CORUA - AC
- AUXILIARY SUPPLY (separate)	230V AC standard
- NOMINAL INPUT VALUES	to be specified when ordering
- NOMINAL OUTPUT VALUES (selectable)	1 - 5 - 10 VDC and 1 - 5 - 10 - 20 - 4/20 mA DC
- RESISTIVE LOAD	700Ω
- MEASURING RANGE	0 ÷ In
- ACCURACY CLASS	0,5
- OVERLOAD	Permanent: 2 In    Instantaneous: 10 In for 1 sec.
- RESPONSE TIME	≤ 300 ms
- ALTERNATED RESIDUAL	≤ 1%
- OPERATING FREQUENCY	50/60 Hz
- BURDEN	current circuit: ≤ 0,8 VA - power supply: ≤ 4VA
- GALVANIC SEPARATION BETWEEN INPUTS AND OUTPUTS	2kV for 1min at 50Hz 4kV for 1min at 50Hz
• insulation between inputs, outputs, power supply	0 °C ÷ +55 °C
• insulation between the all circuits and earth	OS
- OPERATING TEMPERATURE	3 DIN modules / 0,27
- INPUT WAVE FORM	
- DIMENSIONS / WEIGHT Kg.	
- Different technical characteristic can be considered, under specific requests	

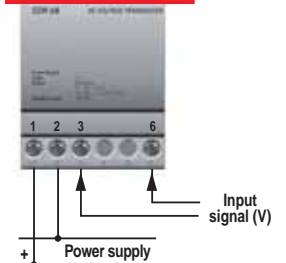
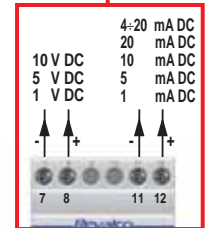

The selection of the required output is achieved by adjusting the minidip keys as described in the following diagram:

Where a Voltage output is required connection is by terminal Nos, 7 and 8 and for Current output connect to terminal Nos, 11 and 12.

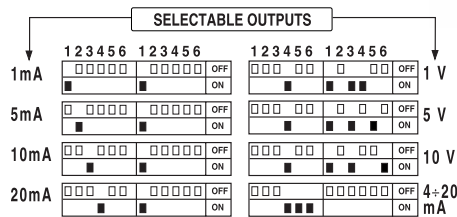

When ordering it is necessary to specify the required input signal

# POWER FACTOR TRANSDUCERS

## 1CORFP10 - 1CORFP20

The transducer have galvanic separation between inputs and outputs and the capability to offer multiple choice by terminal selection and 8 outputs ( $\pm 1, \pm 5, \pm 10$  VDC and  $\pm 1, \pm 5, \pm 10, \pm 20, 4/20$  mA DC). It is also possible to select the required conversion between:

- **proportional to the phase angle**, with output 1mA DC (in degrees) for connection with an analogue measuring instrument.
- **proportional to  $\cos \varphi$**  with output  $\pm 1, \pm 5, \pm 10, \pm 20, \pm 4/20$  mA and  $\pm 1, \pm 5, \pm 10$  V for all other use

- **AUXILIARY SUPPLY (separate)**
- **NOMINAL INPUT VALUES VOLTAGE**

### 1CORFP10 - Single phase

230V AC standard  
230V AC 50/60 Hz  
current: 5A (1A on 1CORFP...B type)  
 $\pm 1, \pm 5, \pm 10$  VDC and  $\pm 1, \pm 5, \pm 10, \pm 20, 4/20$  mA DC  
700 $\Omega$  max / 0,5

### 1CORFP20 - Three phase, balanced load, 3 wires

230V / 400V AC standard  
400V AC 50/60 Hz  
current: 5A (1A on 1CORFP...B type)

- **NOMINAL OUTPUT VALUES (selectable)**
- **RESISTIVE LOAD / ACCURACY CLASS**
- **MEASURING RANGE**
- **OVERLOAD**
- **RESPONSE TIME / ALTERNATED RESIDUAL**
- **BURDEN**
- **GALVANIC SEPARATION BETWEEN INPUTS AND OUTPUTS**

0,5 (cap) - 1 - 0,5 (ind) standard  
**Permanent:** 2 In / 1,2 Un - **Instantaneous:** 10 In / 2 Un for 1 sec  
 $\leq 300$  ms /  $\leq 1\%$

voltage circuit  $\leq 1$ VA current circuit  $\leq 0,8$ VVA power supply  $\leq 4$ VVA  
insulation between inputs, outputs, power supply 2kV for 1min at 50Hz  
insulation between the all circuits and earth 4kV for 1min at 50Hz  
0 °C  $\div$  +55 °C / OS - OSD (schemes D10, D2)  
6 DIN modules / 0,50

- **OPERATING TEMPERATURE / INPUT WAVE FORM**
- **DIMENSIONS / WEIGHT Kg.**
- **Different technical characteristic can be considered, under specific requests**

## 1CORFP10

## 1CORFP20

The selection of the required output is achieved by adjusting the minidip keys as described in the following diagram: where a Voltage output is required connection is by terminal Nos, 13 and 15 and for Current output connect to terminal Nos, 13 and 14. The auxiliary Power Supply is achieved by: use terminal 22 as the common connection; for 230V connect to Terminal 23; for 400V connect to Terminal 24

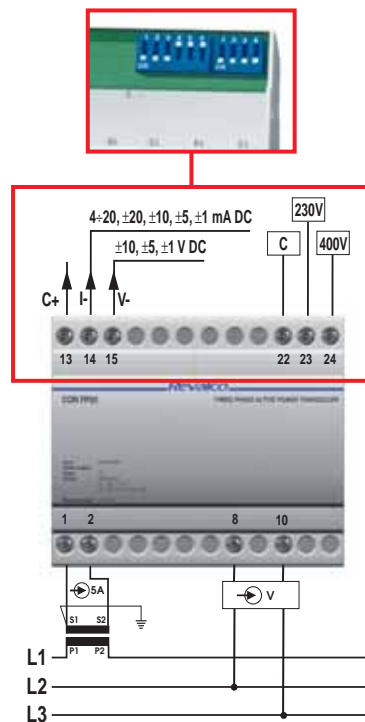
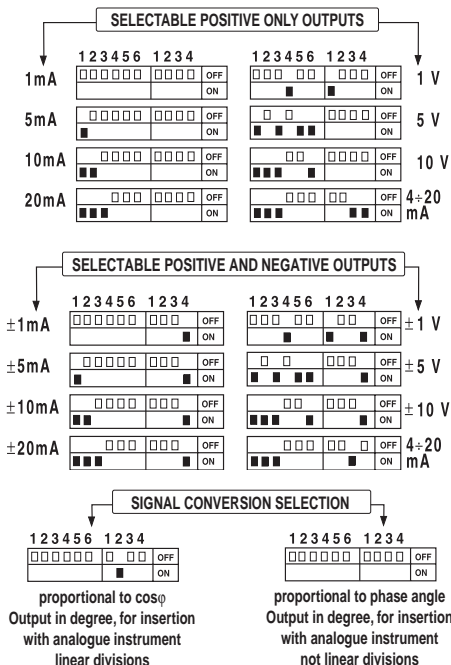
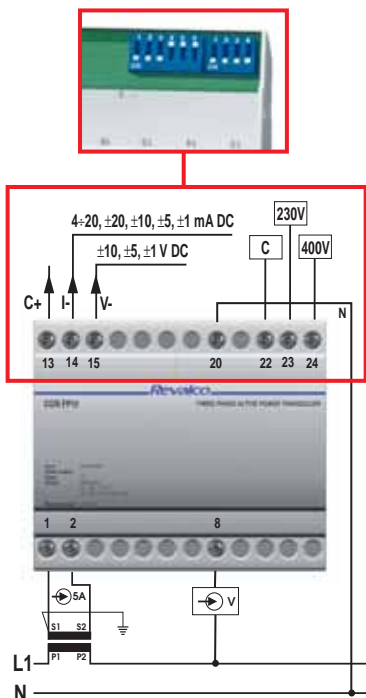

# FREQUENCY TRANSDUCERS

## 1CORF

- **AUXILIARY SUPPLY (separate)**
- **NOMINAL INPUT VALUES VOLTAGE**
- **NOMINAL OUTPUT VALUES (selectable)**
- **RESISTIVE LOAD / ACCURACY CLASS**
- **MEASURING RANGE**
- **OVERLOAD**
- **RESPONSE TIME / ALTERNATED RESIDUAL**
- **BURDEN**
- **GALVANIC SEPARATION BETWEEN INPUTS AND OUTPUTS**

230V AC standard  
100V  $\div$  500V AC  
1 - 5 - 10 - VDC and 1 - 5 - 10 - 20 - 4/20 mA DC  
700 $\Omega$  / 0,5  
45 / 65 Hz standard (other on request)  
**Permanent:** 1,2 Un **Instantaneous:** 2 Un for 1 sec.  
 $\leq 300$  ms /  $\leq 1\%$   
voltage  $\leq 1$ VA power supply  $\leq 4$ VVA

- **OPERATING TEMPERATURE / INPUT WAVE FORM**
- **DIMENSIONS / WEIGHT Kg.**
- **Different technical characteristic can be considered, under specific requests**

2kV for 1min at 50Hz  
4kV for 1min at 50Hz

0 °C  $\div$  +55 °C / OS - OQ - OSP  
3 DIN modules / 0,25

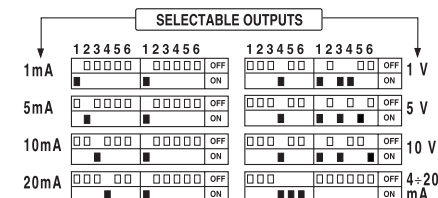

The selection of the required output is achieved by adjusting the minidip keys as described in the diagram.

Where a Voltage output is required connection is by terminal Nos, 7 and 8 and for Current output connect to terminal Nos, 11 and 12

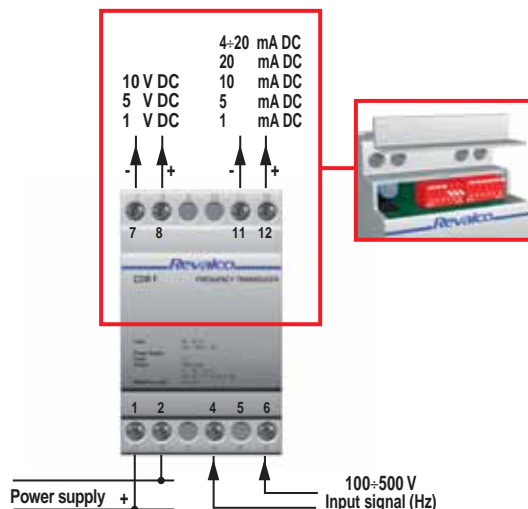

# SINGLE PHASE ACTIVE AND REACTIVE POWER TRANSDUCERS

1CORPA10 / 1CORPR10 - 1CORPA10485 / 1CORPR10485

These transducers have the galvanic separation between inputs and outputs, and have the capability to offer multiple choice auxiliary supply of ( 230V, 400V) by terminal selection and 8 Outputs (1-5-10 VDC and 1-5-10-20-4/20 mA DC), by minidip key located under a removable section of the upper case wall and by terminal selection.

The standard calibration is: 100V, 5A = 500 W (var)    230V, 5A = 1000 W (var)    400V, 5A = 2000 W (var)

## Active Power Reactive Power

- SELECTABLE BIDIRECTIONAL OUTPUTS
- SELECTABLE BIDIRECTIONAL OUTPUTS WITH SERIAL OUTPUT RS485
- MODBUS SLAVE RTU PROTOCOL
- INPUT WAVE FORM
- NOMINAL OUTPUT VALUES (selectable)
- AUXILIARY SUPPLY (separate)
- NOMINAL INPUT VALUES
- RESISTIVE LOAD / MEASURING RANGE
- STANDARD CALIBRATION
- ACCURACY CLASS / OPERATING FREQUENCY
- OVERLOAD
- RESPONSE TIME / ALTERNATED RESIDUAL
- BURDEN
- GALVANIC SEPARATION BETWEEN INPUTS AND OUTPUTS
- OPERATING TEMPERATURE / DIMENSIONS / WEIGHT Kg.

1CORPA10  
1CORPR10

1CORPA10485  
1CORPR10485

OS - OSD (schemes D10, D2)  
 $\pm 1, \pm 5, \pm 10$  VDC and  $\pm 1, \pm 5, \pm 10, \pm 20, 4/20$  mADC  
 230V / 400V AC standard  
 voltage: 230V standard - current: 5A (1A on request)  
 $700\Omega$  max /  $0 \div P_n$  ( $0 \div Q_n$ )  
 100V,5A=500W (var)    230V,5A=1000W (var)    400V,5A=2000W (var)  
 $0,5 / 50 - 60$  Hz  
**Permanent:**  $2 I_n / 1,2 U_n$     **Instantaneous:**  $10 I_n / 2 U_n$  for 1 sec.  
 $\leq 300$  ms /  $\leq 1\%$   
 voltage circuit  $\leq 1$ VA    current circuit  $\leq 0,8$ VVA    power supply  $\leq 4$ VVA  
 insulation between inputs, outputs, power supply 2kV for 1min at 50Hz  
 insulation between the all circuits and earth 4kV for 1min at 50Hz  
 $0^\circ\text{C} \div +55^\circ\text{C}$  / 6 DIN modules / 0,50

**!** Different technical characteristic can be considered, under specific requests.  
 The software is available, free of charge, on our internet address [www.revalco.it](http://www.revalco.it)

1CORPA10 / 1CORPA10485 - 1CORPR10 / 1CORPR10485

The selection of the required output is achieved by adjusting the minidip keys as described in the following diagram:

where a Voltage output is required connection is by terminal Nos, 13 and 15 and for Current output connect to terminal Nos, 13 and 14.

The auxiliary Power Supply is achieved by: use terminal 22 as the common connection; for 230V connect to Terminal 23; for 400V connect to Terminal 24

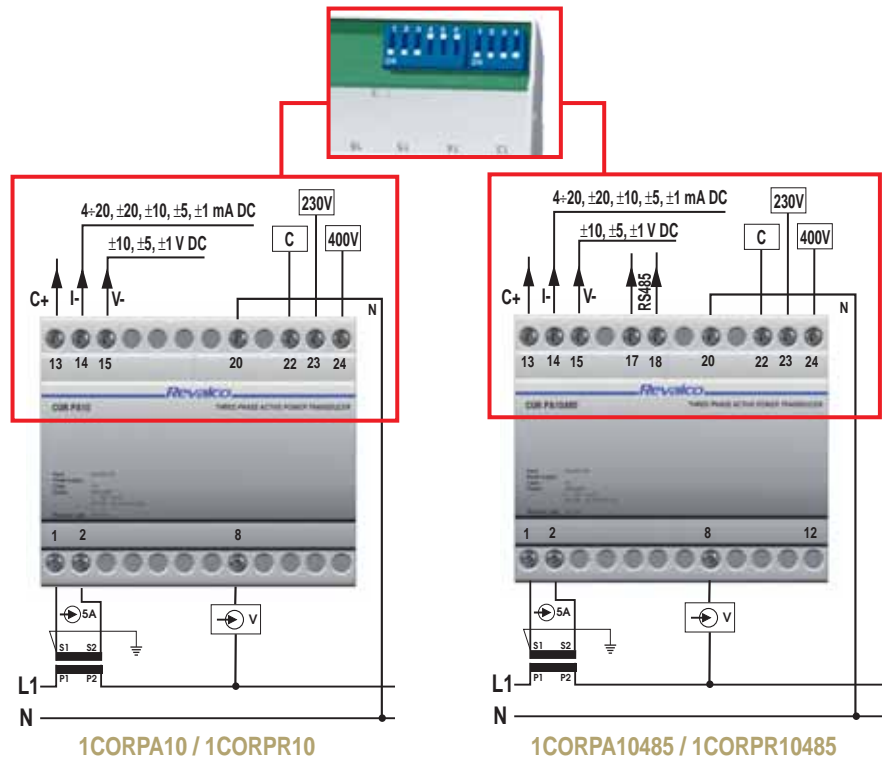
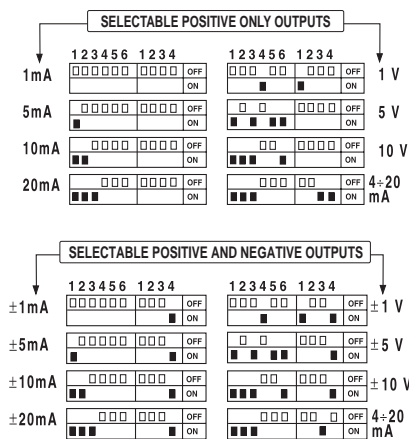

# THREE PHASE ACTIVE AND REACTIVE POWER TRANSDUCERS BALANCED LOAD, 3 WIRES WITHOUT NEUTRAL

1CORPA20 / 1CORPR20 - 1CORPA20485 / 1CORPR20485

These transducers have the galvanic separation between inputs and outputs, and have the capability to offer multiple choice auxiliary supply of ( 230V, 400V) by terminal selection and 8 Outputs ( 1-5-10 VDC and 1-5-10-20-4/20 mA DC), by minidip key located under a removable section of the upper case wall and by terminal selection.

The standard calibration is: 100V, 5A = 1000 W (var) 230V, 5A = 2000 W (var) 400V, 5A = 4000 W (var)

## Active Power Reactive Power

- SELECTABLE BIDIRECTIONAL OUTPUTS
- SELECTABLE BIDIRECTIONAL OUTPUTS WITH SERIAL OUTPUT RS485
- MODBUS SLAVE RTU PROTOCOL
- INPUT WAVE FORM
- NOMINAL OUTPUT VALUES (selectable)
- AUXILIARY SUPPLY (separate)
- NOMINAL INPUT VALUES
- RESISTIVE LOAD / MEASURING RANGE
- STANDARD CALIBRATION
- ACCURACY CLASS / OPERATING FREQUENCY
- OVERLOAD
- RESPONSE TIME / ALTERNATED RESIDUAL
- BURDEN
- GALVANIC SEPARATION BETWEEN INPUTS AND OUTPUTS
- OPERATING TEMPERATURE / DIMENSIONS / WEIGHT Kg.

1CORPA20  
1CORPR20

1CORPA20485  
1CORPR20485

OS - OSD (schemes D10, D2)

$\pm 1, \pm 5, \pm 10$  VDC and  $\pm 1, \pm 5, \pm 10, \pm 20, 4/20$  mADC  
230V / 400V AC standard

voltage: 400V standard - current: 5A (1A on request)  
700Ω max / 0 ÷ Pn (0 ÷ Qn)

100V,5A=1000W (var) 230V,5A=2000W (var) 400V,5A=4000W (var)  
0,5 / 50 - 60 Hz

Permanent: 2 In / 1,2 Un Instantaneous: 10 In / 2 Un for 1 sec.  
≤ 300 ms / ≤ 1%

voltage circuit ≤ 1VA current circuit ≤ 0,8VA power supply ≤ 4VA  
insulation between inputs, outputs, power supply 2kV for 1min at 50Hz  
insulation between the all circuits and earth 4kV for 1min at 50Hz  
0 °C ÷ +55 °C / 6 DIN modules / 0,50



Different technical characteristic can be considered, under specific requests.  
The software is available, free of charge, on our internet address [www.revalco.it](http://www.revalco.it)

1CORPA20 / 1CORPR20 - 1CORPA20485 / 1CORPR20485

The selection of the required output is achieved by adjusting the minidip keys as described in the following diagram:

where a Voltage output is required connection is by terminal Nos, 13 and 15 and for Current output connect to terminal Nos, 13 and 14.

The auxiliary Power Supply is achieved by: use terminal 22 as the common connection; for 230V connect to Terminal 23; for 400V connect to Terminal 24

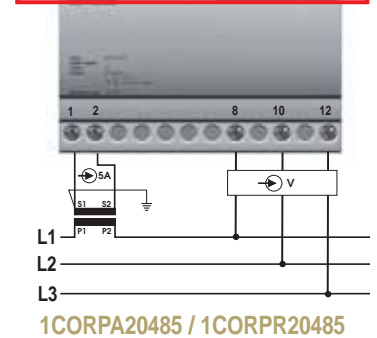
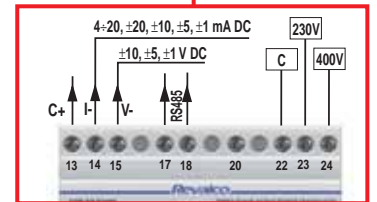
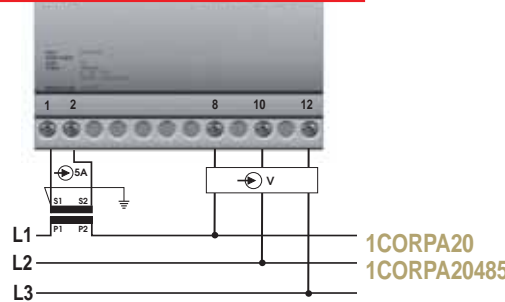
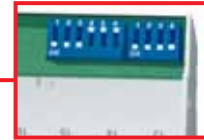
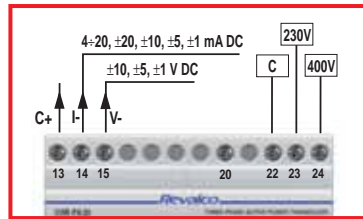
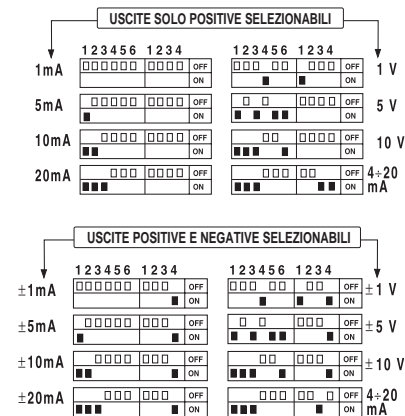

# THREE PHASE ACTIVE AND REACTIVE POWER TRANSDUCERS UNBALANCED LOAD, 3 WIRES WITHOUT NEUTRAL (ARON)

1CORPA30 / 1CORPR30 - 1CORPA30485 / 1CORPR30485

These transducers have the galvanic separation between inputs and outputs, and have the capability to offer multiple choice auxiliary supply of ( 230V, 400V) by terminal selection and 8 Outputs ( 1-5-10 VDC and 1-5-10-20-4/20 mA DC), by minidip key located under a removable section of the upper case wall and by terminal selection. The standard calibration is: 100V, 5A = 1000 W (var) 230V, 5A = 2000 W (var) 400V, 5A = 4000 W (var)

## Active Power Reactive Power

- SELECTABLE BIDIRECTIONAL OUTPUTS
- SELECTABLE BIDIRECTIONAL OUTPUTS WITH SERIAL OUTPUT RS485
- MODBUS SLAVE RTU PROTOCOL
- INPUT WAVE FORM
- NOMINAL OUTPUT VALUES (selectable)
- AUXILIARY SUPPLY (separate)
- NOMINAL INPUT VALUES
- RESISTIVE LOAD / MEASURING RANGE
- STANDARD CALIBRATION
- ACCURACY CLASS / OPERATING FREQUENCY
- OVERLOAD
- RESPONSE TIME / ALTERNATED RESIDUAL
- BURDEN
- GALVANIC SEPARATION BETWEEN INPUTS AND OUTPUTS
- OPERATING TEMPERATURE / DIMENSIONS / WEIGHT Kg.

1CORPA30  
1CORPR30

1CORPA30485  
1CORPR30485

OS - OSD (schemes D10, D2)

$\pm 1, \pm 5, \pm 10$  VDC and  $\pm 1, \pm 5, \pm 10, \pm 20, 4/20$  mADC  
230V / 400V AC standard

voltage: 400V standard - current: 5A (1A on request)

700 $\Omega$  max / 0  $\div$  Pn (0  $\div$  Qn)

100V,5A=1000W (var) 230V,5A=2000W (var) 400V,5A=4000W (var)  
0,5 / 50 - 60 Hz

Permanent: 2 In / 1,2 Un Instantaneous: 10 In / 2 Un for 1 sec.  
 $\leq 300$  ms /  $\leq 1\%$

voltage circuit  $\leq 1$ VA current circuit  $\leq 0,8$ VA power supply  $\leq 4$ VA

insulation between inputs, outputs, power supply 2kV for 1min at 50Hz

insulation between the all circuits and earth 4kV for 1min at 50Hz

0  $^{\circ}$ C  $\div$  +55  $^{\circ}$ C / 6 DIN modules / 0,50



Different technical characteristic can be considered, under specific requests.

The software is available, free of charge, on our internet address [www.revalco.it](http://www.revalco.it)

1CORPA30 / 1CORPR30 - 1CORPA30485 / 1CORPR30485

The selection of the required output is achieved by adjusting the minidip keys as described in the following diagram:

where a Voltage output is required connection is by terminal Nos, 13 and 15 and for Current output connect to terminal Nos, 13 and 14.

The auxiliary Power Supply is achieved by: use terminal 22 as the common connection; for 230V connect to Terminal 23; for 400V connect to Terminal 24

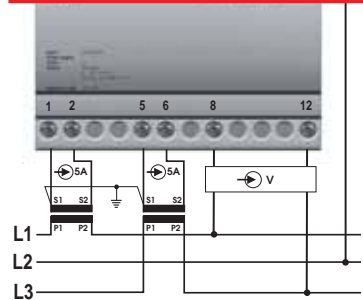
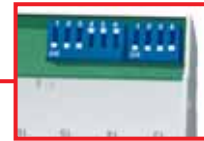
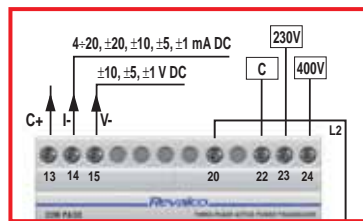
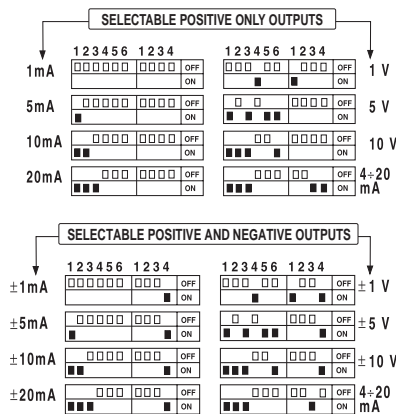

1CORPA30  
1CORPA30485

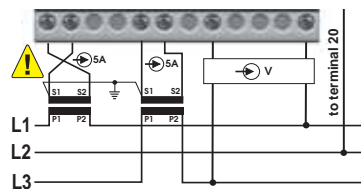

1CORPR30  
1CORPR30485

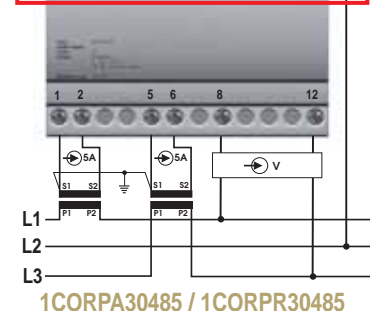
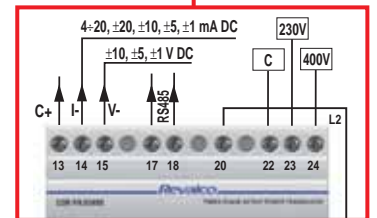

1CORPA30485 / 1CORPR30485

# THREE PHASE ACTIVE AND REACTIVE TRANSDUCERS BALANCED LOAD, 4 WIRES WITH NEUTRAL

1CORPA4 / 1CORPR4 - 1CORPA40 / 1CORPR40 - 1CORPA40485 / 1CORPR40485

These transducers have the galvanic separation between inputs and outputs, and have the capability to offer multiple choice auxiliary supply of ( 230V, 400V) by terminal selection and 8 Outputs ( 1-5-10 VDC and 1-5-10-20-4/20 mA DC), by minidip key located under a removable section of the upper case wall and by terminal selection. The standard calibration is: 100V, 5A = 1000 W (var) 230V, 5A = 2000 W (var) 400V, 5A = 4000 W (var)

## Active Power Reactive Power

- SELECTABLE BIDIRECTIONAL OUTPUTS
- SELECTABLE BIDIRECTIONAL OUTPUTS WITH SERIAL OUTPUT RS485
- MODBUS SLAVE RTU PROTOCOL
- INPUT WAVE FORM
- NOMINAL OUTPUT VALUES (selectable)
- AUXILIARY SUPPLY (separate)
- NOMINAL INPUT VALUES
- RESISTIVE LOAD / MEASURING RANGE
- STANDARD CALIBRATION
- ACCURACY CLASS / OPERATING FREQUENCY
- OVERLOAD
- RESPONSE TIME / ALTERNATED RESIDUAL
- BURDEN
- GALVANIC SEPARATION BETWEEN INPUTS AND OUTPUTS
- OPERATING TEMPERATURE / DIMENSIONS / WEIGHT Kg.

1CORPA40  
1CORPR40

1CORPA40485  
1CORPR40485

OS - OSD (schemes D10, D2)

$\pm 1, \pm 5, \pm 10$  VDC and  $\pm 1, \pm 5, \pm 10, \pm 20, 4/20$  mADC  
230V / 400V AC standard

voltage: 400V standard - current: 5A (1A on request)

700 $\Omega$  max / 0  $\div$  Pn (0  $\div$  Qn)

100V,5A=1000W (var) 230V,5A=2000W (var) 400V,5A=4000W (var)  
0,5 / 50 - 60 Hz

**Permanent:** 2 In / 1,2 Un **Instantaneous:** 10 In / 2 Un for 1 sec.  
 $\leq 300$  ms /  $\leq 1\%$

voltage circuit  $\leq 1$ VA current circuit  $\leq 0,8$ VA power supply  $\leq 4$ VA

insulation between inputs, outputs, power supply 2kV for 1min at 50Hz

insulation between the all circuits and earth 4kV for 1min at 50Hz

0  $^{\circ}$ C  $\div$  +55  $^{\circ}$ C / 6 DIN modules / 0,50



Different technical characteristic can be considered, under specific requests.

The software is available, free of charge, on our internet address [www.revalco.it](http://www.revalco.it)

1CORPA40 / 1CORPR40 - 1CORPA40485 / 1CORPR40485

The selection of the required output is achieved by adjusting the minidip keys as described in the following diagram:

where a Voltage output is required connection is by terminal Nos, 13 and 15 and for Current output connect to terminal Nos, 13 and 14.

The auxiliary Power Supply is achieved by: use terminal 22 as the common connection; for 230V connect to Terminal 23; for 400V connect to Terminal 24

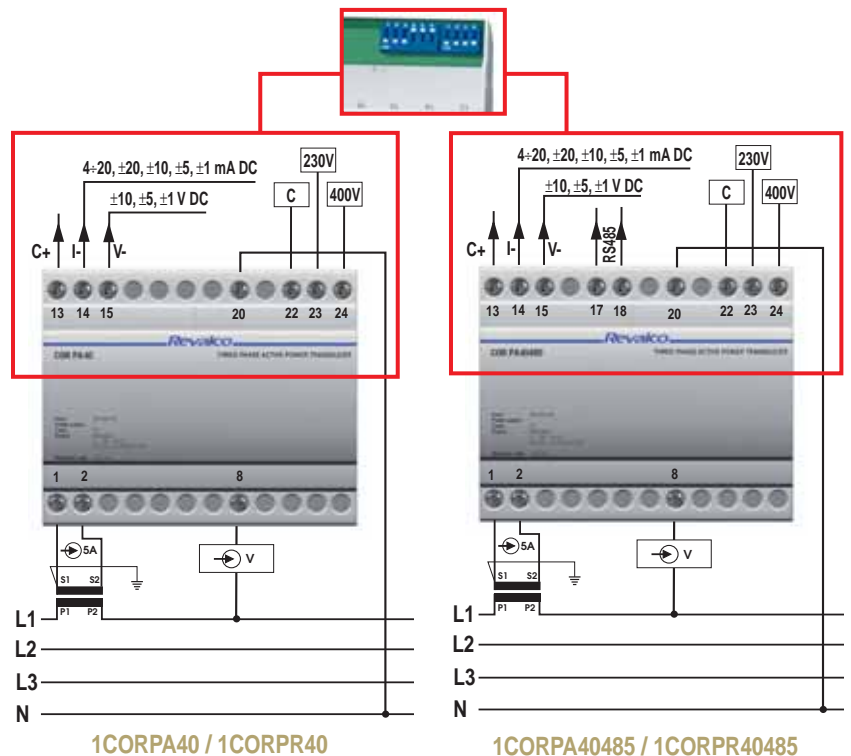
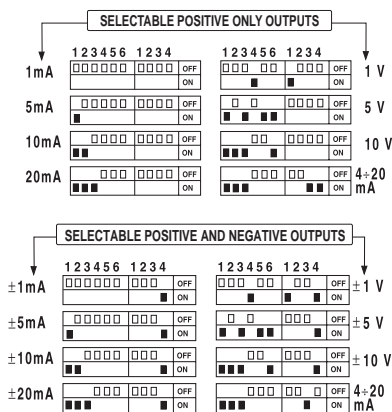

# THREE PHASE ACTIVE AND REACTIVE TRANSDUCERS UNBALANCED LOAD, 4 WIRES WITH NEUTRAL

1CORPA50 / 1CORPR50 - 1CORPA50485 / 1CORPR50485 - 1CORPAC50485 / 1CORPRC50485

These transducers have the galvanic separation between inputs and outputs, and have the capability to offer multiple choice auxiliary supply of ( 230V, 400V) by terminal selection and 8 Outputs (1-5-10 VDC and 1-5-10-20-4/20 mA DC), by minidip key located under a removable section of the upper case wall and by terminal selection. The standard calibration is: 100V, 5A = 1000 W (var) 230V, 5A = 2000 W (var) 400V, 5A = 4000 W (var)

## Active Power Reactive Power

- SELECTABLE BIDIRECTIONAL OUTPUTS
- SELECTABLE BIDIRECTIONAL OUTPUTS WITH SERIAL OUTPUT RS485
- MODBUS SLAVE RTU PROTOCOL
- INPUT WAVE FORM
- NOMINAL OUTPUT VALUES (selectable)
- AUXILIARY SUPPLY (separate)
- NOMINAL INPUT VALUES
- RESISTIVE LOAD / MEASURING RANGE
- STANDARD CALIBRATION
- ACCURACY CLASS / OPERATING FREQUENCY
- OVERLOAD
- RESPONSE TIME / ALTERNATED RESIDUAL
- BURDEN
- GALVANIC SEPARATION BETWEEN INPUTS AND OUTPUTS
- OPERATING TEMPERATURE / DIMENSIONS / WEIGHT Kg.



Different technical characteristic can be considered, under specific requests.  
The software is available, free of charge, on our internet address [www.revalco.it](http://www.revalco.it)

1CORPA50  
1CORPR50

1CORPA50485  
1CORPR50485

OS - OSD (schemes D10, D2)

$\pm 1, \pm 5, \pm 10$  VDC and  $\pm 1, \pm 5, \pm 10, \pm 20, 4/20$  mADC  
230V / 400V AC standard

voltage: 400V standard - current: 5A (1A on request)  
700 $\Omega$  max / 0  $\div$  Pn (0  $\div$  Qn)

100V,5A=1000W (var) 230V,5A=2000W (var) 400V,5A=4000W (var)  
0,5 / 50 - 60 Hz

Permanent: 2 In / 1,2 Un Instantaneous: 10 In / 2 Un for 1 sec.  
 $\leq 300$  ms /  $\leq 1\%$

voltage circuit  $\leq 1$ VA current circuit  $\leq 0,8$ VA power supply  $\leq 4$ VA  
insulation between inputs, outputs, power supply 2kV for 1min at 50Hz  
insulation between the all circuits and earth 4kV for 1min at 50Hz  
0 °C  $\div$  +55 °C / 6 DIN modules / 0,50

1CORPA50 / 1CORPR50 - 1CORPA50485 / 1CORPR50485

The selection of the required output is achieved by adjusting the minidip keys as described in the following diagram:

where a Voltage output is required connection is by terminal Nos, 13 and 15 and for Current output connect to terminal Nos, 13 and 14.

The auxiliary Power Supply is achieved by: use terminal 22 as the common connection; for 230V connect to Terminal 23; for 400V connect to Terminal 24

